

ALL FOR LIFE



ADBLUE/DEF TRANSTER

Use for: Aus32,Urea,Water,Diesel,Oil,Fuel
 Pump Design: Diaphragm
 Flow Rate: 34L/Min or 9GPM
 DutyCycle: Continue

Wetted Parts: Housing ----- Polypropylene
 Diaphragm-----EPDM
 Check Valve-----Viton
 Check Valve Spring----- 316 stainless steel
 Motor shaft----- 316 stainless steel

Port type: 3/4 INLET AND OUTLET
 Operating Pressure: 40PSI (3Bar) Maximum
 Switch Setting: YES
 Self-Priming: Up to 4M Vertically
 Liquid Temperature: 80°C Max.
 Motor Type: AC Motor 330W FOR 220V
 Net weight is 6kg Gross weight is 6.5kg



Model	Volts	Open Flow	Pressure	Connection		Check
		L/Min	on / off	In	out	valve
GP30012	12V	34	30PSI	1inch	1inch	viton
GP30024	24V	34	30PSI	1inch	1inch	viton
GP30230	230V	34	30PSI	1inch	1inch	viton
GP40230	230V	40	30PSI	1inch	1inch	viton
GP50230	230V	50	30PSI	1inch	1inch	viton
GP30115	115V	34	30PSI	1inch	1inch	viton
GP40115	115V	40	30PSI	1inch	1inch	viton
GP50115	115V	50	30PSI	1inch	1inch	viton



Model	Volts	Open Flow	Pressure	Connection		Check
		L/Min	on / off	In	out	valve
GP30012H	12V	34	30PSI	1inch	1inch	viton
GP30024H	24V	34	30PSI	1inch	1inch	viton
GP30230H	230V	34	30PSI	1inch	1inch	viton
GP40230H	230V	40	30PSI	1inch	1inch	viton
GP50230H	230V	50	30PSI	1inch	1inch	viton
GP30115H	115V	34	30PSI	1inch	1inch	viton
GP40115H	115V	40	30PSI	1inch	1inch	viton
GP50115H	115V	50	30PSI	1inch	1inch	viton

ADBLUE/DEF TRANSTER



- Diaphragm pump
- 3/4 automatic nozzle
- 2M suction hose (EPDM)
- 4M delivery hose (EPDM)
- 3/4 nozzle fitting
- Bracket



IBC kit for Adblue
 40LPM adblue pump 12v or 230v
 Auto nozzle
 2M suction hose
 4m delivery hose
 SEC with CDS connector
 SS304 IBC bracket
 4PCS rubber feet with motor bolts

IBC PUMP KIT

ADBLUE PUMP COMPLETE

Model	Volts	Open Flow	Pressure	Connection		Check	Nozzle	Meter
		L/Min	on / off	In	out	valve		
GPSS30012E	12V	34	30PSI	1inch	1inch	viton	SS01	NO
GPSS30024E	24V	34	30PSI	1inch	1inch	viton	SS01	NO
GPSS30230E	230V	34	30PSI	1inch	1inch	viton	SS01	NO
GPSS40230E	230V	40	30PSI	1inch	1inch	viton	SS01	NO
GPSS50230E	230V	50	30PSI	1inch	1inch	viton	SS01	NO
GPSS30115E	115V	34	30PSI	1inch	1inch	viton	SS01	NO
GPSS40115E	115V	40	30PSI	1inch	1inch	viton	SS01	NO
GPSS50115E	115V	50	30PSI	1inch	1inch	viton	SS01	NO
GPPN30012E	12V	34	30PSI	1inch	1inch	viton	PN01	NO
GPPN30024E	24V	34	30PSI	1inch	1inch	viton	PN01	NO
GPPN30230E	230V	34	30PSI	1inch	1inch	viton	PN01	NO
GPPN40230E	230V	40	30PSI	1inch	1inch	viton	PN01	NO
GPPN50230E	230V	50	30PSI	1inch	1inch	viton	PN01	NO
GPPN30115E	115V	34	30PSI	1inch	1inch	viton	PN01	NO
GPPN40115E	115V	40	30PSI	1inch	1inch	viton	PN01	NO
GPPN50115E	115V	50	30PSI	1inch	1inch	viton	PN01	NO

ADBLUE/DEF TRANSTER



- Diaphragm pump
- 3/4 automatic nozzle
- 2M suction hose (EPDM)
- 4M delivery hose (EPDM)
- 3/4 nozzle fitting
- AFM30 FLOW METER
- Bracket



IBC PUMP KIT

ADBLUE PUMP COMPLETE

Model	Volts	Open Flow	Pressure	Connection		Check	Nozzle	Meter
		L/Min	on / off	In	out	valve		
GPSS30012T	12V	34	30PSI	1inch	1inch	viton	SS01	AFM30
GPSS30024T	24V	34	30PSI	1inch	1inch	viton	SS01	AFM30
GPSS30230T	230V	34	30PSI	1inch	1inch	viton	SS01	AFM30
GPSS40230T	230V	40	30PSI	1inch	1inch	viton	SS01	AFM30
GPSS50230T	230V	50	30PSI	1inch	1inch	viton	SS01	AFM30
GPSS30115T	115V	34	30PSI	1inch	1inch	viton	SS01	AFM30
GPSS40115T	115V	40	30PSI	1inch	1inch	viton	SS01	AFM30
GPSS50115T	115V	50	30PSI	1inch	1inch	viton	SS01	AFM30
GPPN30012T	12V	34	30PSI	1inch	1inch	viton	PN01	AFM30
GPPN30024T	24V	34	30PSI	1inch	1inch	viton	PN01	AFM30
GPPN30230T	230V	34	30PSI	1inch	1inch	viton	PN01	AFM30
GPPN40230T	230V	40	30PSI	1inch	1inch	viton	PN01	AFM30
GPPN50230T	230V	50	30PSI	1inch	1inch	viton	PN01	AFM30
GPPN30115T	115V	34	30PSI	1inch	1inch	viton	PN01	AFM30
GPPN40115T	115V	40	30PSI	1inch	1inch	viton	PN01	AFM30
GPPN50115T	115V	50	30PSI	1inch	1inch	viton	PN01	AFM30

ADBLUE/DEF TRANSTER



- Diaphragm pump
- 3/4 automatic nozzle
- 2M suction hose (EPDM)
- 4M delivery hose (EPDM)
- 3/4 nozzle fitting
- Bracket



DRUM PUMP KIT

Model	Volts	Open Flow	Pressure	Connection		Check	Nozzle	Meter
		L/Min	on / off	In	out	valve		
GPSS30012S	12V	34	30PSI	1inch	1inch	viton	SS01	NO
GPSS30024S	24V	34	30PSI	1inch	1inch	viton	SS01	NO
GPSS30230S	230V	34	30PSI	1inch	1inch	viton	SS01	NO
GPSS40230S	230V	40	30PSI	1inch	1inch	viton	SS01	NO
GPSS50230S	230V	50	30PSI	1inch	1inch	viton	SS01	NO
GPSS30115S	115V	34	30PSI	1inch	1inch	viton	SS01	NO
GPSS40115S	115V	40	30PSI	1inch	1inch	viton	SS01	NO
GPSS50115S	115V	50	30PSI	1inch	1inch	viton	SS01	NO
GPPN30012S	12V	34	30PSI	1inch	1inch	viton	PN01	NO
GPPN30024S	24V	34	30PSI	1inch	1inch	viton	PN01	NO
GPPN30230S	230V	34	30PSI	1inch	1inch	viton	PN01	NO
GPPN40230S	230V	40	30PSI	1inch	1inch	viton	PN01	NO
GPPN50230S	230V	50	30PSI	1inch	1inch	viton	PN01	NO
GPPN30115S	115V	34	30PSI	1inch	1inch	viton	PN01	NO
GPPN40115S	115V	40	30PSI	1inch	1inch	viton	PN01	NO
GPPN50115S	115V	50	30PSI	1inch	1inch	viton	PN01	NO

ADBLUE/DEF TRANSTER



- Diaphragm pump
- 3/4 automatic nozzle
- 2M suction hose (EPDM)
- 4M delivery hose (EPDM)
- 3/4 nozzle fitting
- AFM30 FLOW METER
- Bracket

DRUM PUMP KIT

Model	Volts	Open Flow	Pressure	Connection		Check	Nozzle	Meter
		L/Min	on / off	In	out	valve		
GPSS30012D	12V	34	30PSI	1inch	1inch	viton	SS01	AFM30
GPSS30024D	24V	34	30PSI	1inch	1inch	viton	SS01	AFM30
GPSS30230D	230V	34	30PSI	1inch	1inch	viton	SS01	AFM30
GPSS40230D	230V	40	30PSI	1inch	1inch	viton	SS01	AFM30
GPSS50230D	230V	50	30PSI	1inch	1inch	viton	SS01	AFM30
GPSS30115D	115V	34	30PSI	1inch	1inch	viton	SS01	AFM30
GPSS40115D	115V	40	30PSI	1inch	1inch	viton	SS01	AFM30
GPSS50115D	115V	50	30PSI	1inch	1inch	viton	SS01	AFM30
GPPN30012D	12V	34	30PSI	1inch	1inch	viton	PN01	AFM30
GPPN30024D	24V	34	30PSI	1inch	1inch	viton	PN01	AFM30
GPPN30230D	230V	34	30PSI	1inch	1inch	viton	PN01	AFM30
GPPN40230D	230V	40	30PSI	1inch	1inch	viton	PN01	AFM30
GPPN50230D	230V	50	30PSI	1inch	1inch	viton	PN01	AFM30
GPPN30115D	115V	34	30PSI	1inch	1inch	viton	PN01	AFM30
GPPN40115D	115V	40	30PSI	1inch	1inch	viton	PN01	AFM30
GPPN50115D	115V	50	30PSI	1inch	1inch	viton	PN01	AFM30

ADBLUE/DEF TRANSTER

Pump Design: Diaphragm

DutyCycle: Continue

Wetted Parts: Housing ----- Polypropylene

Diaphragm-----EPDM

Check Valve-----Viton

Check Valve Spring----- 316 stainless steel

Motor shaft----- 316 stainless steel

Switch Setting: YES

Self-Priming: Up to 4M Vertically

Liquid Temperature: 80°C Max.

Motor Type: DC Motor



MODEL	FLOW RATE	VOLT	PRESSURE	SWITCH	I/O HOSE TAIL	WEIGHT
GP17230	17LPM	230V	40PSI	YES	1" or 3/4"	5KGS
GP26230	26LPM	230V	40PSI	YES	1" or 3/4"	5KGS



MODEL	FLOW RATE	VOLT	PRESSURE	SWITCH	I/O HOSE TAIL	WEIGHT
GPSS26230T	26LPM	230V	40PSI	YES	1"or 3/4"	15KGS
GPSS2612T	26LPM	12V	40PSI	YES	1" or 3/4"	15KGS
GPSS2624T	26LPM	24V	40PSI	YES	1" or 3/4"	15KGS
GPPN26230T	26LPM	230V	40PSI	YES	1"or 3/4"	12.5KGS
GPPN2612T	26LPM	12V	40PSI	YES	1" or 3/4"	12.5KGS
GPPN2624T	26LPM	24V	40PSI	YES	1" or 3/4"	12.5KGS
GPSS26230E	26LPM	230V	40PSI	YES	1"or 3/4"	14.5KGS
GPSS2612E	26LPM	12V	40PSI	YES	1" or 3/4"	14.5KGS
GPSS2624E	26LPM	24V	40PSI	YES	1" or 3/4"	14.5KGS
GPPN26230E	26LPM	230V	40PSI	YES	1"or 3/4"	12KGS
GPPN2624E	26LPM	24V	40PSI	YES	1" or 3/4"	12KGS
GPPN2612E	26LPM	12V	40PSI	YES	1" or 3/4"	12KGS
GP26230E	26LPM	230V	40PSI	YES	1"or 3/4"	11KGS
GP2612E	26LPM	12V	40PSI	YES	1" or 3/4"	12KGS
GP2624E	26LPM	24V	40PSI	YES	1" or 3/4"	11KGS

USE FOR SOLAR /RV/MARINE/AG/INDUSTRY ADBLUE/OIL/DEF/DIESEL/WATER/PETROL/FOOD GRADE FUEL/ALCOHOL /FUEL

Pump Design: Diaphragm

DutyCycle: Continue

Wetted Parts: Housing ----- Polypropylene
 Diaphragm-----EPDM
 Check Valve-----Viton
 Check Valve Spring----- 316 stainless steel
 Motor shaft----- 316 stainless steel

Switch Setting: YES

Self-Priming: Up to 4M Vertically

Liquid Temperature: 80°C Max.

Motor Type: DC Motor



MODEL	FLOW RATE	VOLT	PRESSURE	SWITCH	I/O HOSE TAIL	WEIGHT
FL111012(FLN30)	10LPM	12V	30PSI	YES	1/2" or 3/4"	3KGS
FL111024(FLN31)	10LPM	24V	30PSI	YES	1/2" or 3/4"	3KGS
FL1112512(FLN35)	12.5LPM	12V	35PSI	YES	1/2" or 3/4"	3KGS
FL1112524(FLN34)	12.5LPM	24V	35PSI	YES	1/2" or 3/4"	3KGS
FL111712(FLN40)	17LPM	12V	40PSI	YES	3/4"	3KGS
FL111724(FLN44)	17LPM	24V	40PSI	YES	3/4"	3KGS
FL111712H(FLN40)	17LPM	12V	60-120PSI	YES	3/4"	3KGS
FL111724H(FLN44)	17LPM	24V	60-120PSI	YES	3/4"	3KGS



MODEL	FLOW RATE	VOLT	PRESSURE	SWITCH	I/O HOSE TAIL	WEIGHT
GP17012	17LPM	12V	40PSI	YES	1" or 3/4"	4.5KGS
GP17024	17LPM	24V	40PSI	YES	1" or 3/4"	4.5KGS
GP26012	26LPM	12V	40PSI	YES	1" or 3/4"	4.5KGS
GP26024	26LPM	24V	40PSI	YES	1" or 3/4"	4.5KGS

ADBLUE/DEF TRANSTER

For use with a 1 to 5 gallon (3 to 20 liter)

accumulator tank-4.5gpm(17.0lpm)

-Provides quiet operation and smooth flow

-Runs dry without damage to the pump

-Includes plug-in ports for easy installation:

Two 1/2" hose barb ports.

Two 1/2" garden hose ports.

-Install with strainer (included) to protect pump from debris.



Model	Volts	Flow Rate L/Min	Pressure Off	Amp Draw at 10 psi	Strainer Incl
FL111012	12V	10	17psl	2.2	Yes
FL111024	24V	10	17psl	1.5	Yes
FL1112524	24V	12.5	35psl	2.0	Yes
FL1112512	12V	12.5	35psl	3.9	Yes
FL111712	12V	17	40psl	6	Yes
FL111724	24V	17	40psl	2.5	Yes
FL11125220	220V	12.5	35psl	0.4	Yes
FL11125115	115V	12.5	35psl	0.5	Yes
FL1117115	115V	17	40psl	0.6	Yes
FL1117220	220V	17	40psl	0.4	Yes



Model	Volts	Flow Rate	Pressure Off	Amp Draw	Strainer
FL26220	220V	26L/M	60psl	0.4	Yes
FL26115	115V	26L/M	60psl	0.7	Yes
FL26012	12V	26L/M	60psl	7.4	Yes
FL26024	24V	26L/M	60psl	3.7	Yes

ADBLUE/DEF TRANSTER



ELECTRIC DC ADBLUE PUMP
 Model:GP17012
 Flowrate:17LPM
 Power:120W
 Volt:12V
 Use for all Adblue tanks



ELECTRIC DC ADBLUE PUMP
 Model:GP26012
 Flowrate:26LPM
 Power:180W
 Volt:12V
 Use for all Adblue tanks



ELECTRIC DC ADBLUE PUMP
 Model:GP30012
 Flowrate:30LPM
 Power:280W
 Volt:12V
 Use for all Adblue tanks



EPDM HOSE FOR ADBLUE TANK
 19MM-27MM DIAMETER



NBR HOSE FOR DIESEL TANK
 19-27MM DIAMETER 3/4IN
 26-32MM DIAMETER 1IN

ADBLUE/DEF TRANSTER



GPF30230/GPF30012 ADBLUE PUMP COMPLETE

- 34L/M diaphragm pump
- 3/4 Stainless Steel automatic nozzle
- 2M suction hose (EPDM)
- 4M delivery hose (EPDM)
- 3/4 stainless steel nozzle fitting



GPF111712 ADBLUE PUMP COMPLETE

- 17L/M diaphragm pump
- 3/4 Stainless Steel automatic nozzle
- 2M suction hose (EPDM)
- 4M delivery hose (EPDM)
- 3/4 stainless steel nozzle fitting



Technical parameters:

Product Name:	plastic hand pump CM2100
Material:	Plastic-PP
inlet diameter :	27mm
outlet diameter :	25mm
Product Length:	1280mm
Output flowing:	21L/min
Suction	3m
Lift:	5m
Pressure:	360 Psi
SPEED:	70R/min
Packing:	10PCS/CTN
Package Size:	80*38*38cm
Weight:	NW:13kg GW:14kg

ADBLUE/DEF TRANSTER



- Model:EDP20A**
- Flow rate:19LPM/5GPM
 - Motor:30W
 - Volt:12V,115V OR 230V
 - Use for 205L drum
 - Transfer for ADBLUE/CHEMICAL



- Model:EDP20A**
- Flow rate:19LPM/5GPM
 - Motor:30W
 - Volt:12V,115V OR 230V
 - Use for 205L drum
 - Transfer for Diesel



- MODEL:RP20A-S**
- with56 and70mmdrum adaptor
 - with IBC CAP
 - Convenient ON/OFF switch with LED indicator
 - Fitted with fuse for protection with a silence submersible pump
 - Telescopic suction tube from 980-1250mm
 - Suitable for 205Ldrum and 1000LIBCtank
 - Include3200mAh Lithium Battery can transfer 800Ladblue/diesel
 - Chargetime:3Hours
 - Flowrate:20LPM
 - Supplied with 2M hose and manual dispensing nozzle
 - Suitable for pumping DEF/Adblue/Urea,antifreeze,water,detergents,diesel



- MODEL:RP20A**
- with56 and70mmdrum adaptor
 - Convenient ON/OFF switch with LED indicator
 - Fitted with fuse for protection with a silence submersible pump
 - Telescopic suction tube from 980-1250mm
 - Suitable for 205Ldrum and 1000LIBCtank
 - Include3200mAh Lithium Battery can transfer 800Ladblue/diesel
 - Chargetime:3Hours
 - Flowrate:20LPM
 - Supplied with 2M hose and manual dispensing nozzle
 - Suitable for pumping DEF/Adblue/Urea,antifreeze,water,detergents,diesel

ADBLUE/DEF TRANSTER

Model CM0500: ADBLUE HAND PUMP

Pump outlet is fitted with an air vent cap, which when loosened breaks the siphon action
Supplied complete with suction tube for use with 50–205ltr drums and 2m " flexible corrugated discharge hose

Wetted components: polyacetal, polypropylene, polyethylene, viton
For use with: Adblue, water based media, detergents, soaps, antifreeze, windscreen washer, hydraulic oils, herbicides and pesticides

Do not use with: Any media not compatible with materials used in the pump construction. These pumps must not be used for fuel transfer or with solvent thinners etc

Flow rate:500mm



ADBLUE/DEF TRANSTER



MODEL: PN01

Plastic Manual Nozzle for AUS32/DEF
Inlet 3/4 BSP



MODEL: PN02

Plastic Manual Nozzle for AUS32/DEF
Inlet 3/4 BSP



MODEL: SS01

Stainless Steel Automatic Nozzle for Aus32/Urea
Inlet 3/4 BSP Out 13/16 or 15/16



MODEL: AD11PP

Plastic nozzle Automatic Nozzle for Aus32/Urea
Inlet 3/4 BSP Out 13/16 or 15/16



MODEL: AD11PP-M

Plastic nozzle Automatic Nozzle With magnet
for Aus32/Urea Inlet 3/4 BSP Out 13/16 or 15/16

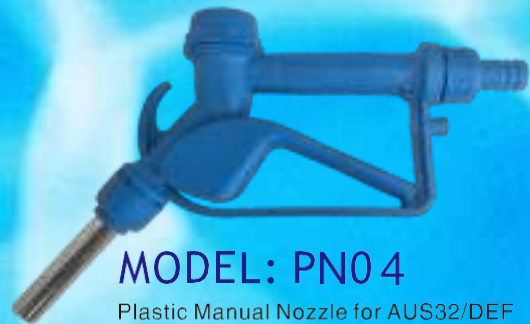

MODEL: PN04

Plastic Manual Nozzle for AUS32/DEF
Inlet 3/4 BSP



MODEL: SS01-M

Stainless Steel Automatic Nozzle With magnet for
Aus32/Urea Inlet 3/4 BSP Out 13/16 or 15/16

ADBLUE/DEF TRANSTER

AdBlue Automatic Nozzle with Built-in Meter

- Flow rates of up to 35 L/min
- Inlet thread: 1" BSP (m)
- Spout diameter: 19mm
- Light (0.65kg), ergonomic & easy to handle



AD13PP



AD12PP



**FLOW METER
MODEL: FM30**

Easy to Install Inline or at the end of a delivery Hose
1" Female / Female Threaded BSP/NPT
Accuracy +/- 0.5%
10 - 90 litres per minute flow rate
Display can be rotated into 4 positions



**FLOW METER
MODEL: AFM30**

Easy to Install Inline or at the end of a delivery Hose
1" Female / Female Threaded BSP/NPT
Accuracy +/- 0.5%
10 - 90 litres per minute flow rate
Display can be rotated into 4 positions



P01



P02



P03



P04



P05



P06



P08



PF01 3/4 and 1 inch plastic filter



MF 3/4 and 1inch copper foot value



PF02 3/4 fitting



CDS 2inch- 3/4inch plastic IBC bottom connector



IBC1000 tank cap



MODEL ST-01 SUCTION TUBE



MODEL ST-02 SUCTION TUBE

ADBLUE/DEF TRANSFER



MODEL:SEC01

CDS/SEC for IBC or Drum use



MODEL:SEC02

CDS/SEC for IBC or Drum use



3/4 Urea Hose



MODEL: IBC01

stainless Steel Bracket for IBC use

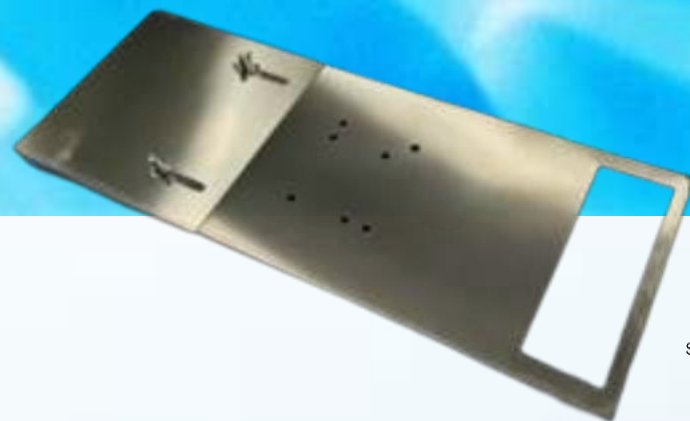

MODEL: DRU01

stainless Steel Bracket for Drum use

DC SUBMERSIBLE PUMP

MODEL	Wp01235	Wp02435
FLOW RATE	35L/MIN 9GPM	35L/MIN 9GPM
VOLTAGE	12V	24V
AMPS	6.4A	3.2A
PRESSURE	60PSI	50PSI
OUTLET	3/4INCH	3/4INCH
CABLE SIZE:	3M	3M
PACKING	20PCS/CTM	20PCS/CTN
G.W/N.W	13.5/11.5KGS	13.5/11.5KGS
PACKING SIZE	31.5x39x21.5CM	31.5x39x21.5CM



ADBLUE/DEF/UREA/DIESEL/GASOLINE/WATER /FUEL HOSE REEL

Plastic drum

Stainless steel arm and base, or steel arm and base with powder coating(more cheaper than stainless steel)

Stainless steel fitting and swivel adapter

Working pressure 20bar

3/4"EPDM hose ,length is 8M

Leading hose 3/4"x1m EPDM hose

Viton seal



MODEL		DIMENSION	WEIGHT
CM008A	STEEL ARM AND BASE WITH POWDER COATING	55X29X55CM	18/20KGS
CM008S	STAINLESS STEEL ARM AND BASE	55X29X55CM	18/20KGS

FUEL TRANSFER PUMP



ELECTRIC DC DIESEL PUMP

Model:DP40012
Flowrate:40LPM
Power:180W
Volt:12V
Use for all diesel tanks



ELECTRIC DC DIESEL PUMP

Model:DP50012
Flowrate:50LPM
Power:180W
Volt:12V
Use for all diesel tanks



ELECTRIC DC DIESEL PUMP

Model:DP40230
Flowrate:40LPM
Power:180W
Volt:230V
Use for all diesel tanks



ELECTRIC DC DIESEL PUMP KIT

Model:DP40012
Flowrate:40LPM
Power:180W
Volt:230V
Manual nozzle
2M pvc suction hose with filter
2M NBR delivery hose



ELECTRIC DC DIESEL PUMP

Model:DP60012
Flowrate:60LPM
Power:300W
Volt:12V
Use for all diesel tanks

FUEL TRANSFER PUMP



MODEL:GP40A
40LPM Diesel pump 12v
FM120 Meter
2M PVC suction hose
4M NBR delivery hose
11A auto nozzle
Filter
Bracket



MODEL:GP60A
56LPM Diesel pump 230v
FM120 Meter
2M PVC suction hose
J60A manual nozzle
Filter
Bracket



MODEL:GP80A
80LPM Diesel pump 230v
FM120 Meter
2M PVC suction hose
J60A manual nozzle
Filter
Bracket

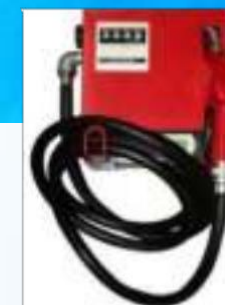

MODEL:JYB60
For diesel, Kerosene
Flow rate: 20-60L/min
Working pressure: 3Bar
Power: AC220/AC110

HOSE REEL



HOSE REEL
 USE FOR AD BLUE DEF UREA DIESEL GASOLINE PETROL WATER FUEL
 Plastic drum
 stainless steel arm and base, or steel arm and base with powder coating more cheaper than stainless steel
 Stainless steel fitting and swivel adapter
 Working pressure 20Bar

Model	Inlet/outlet Size	Hose	ARM AND BASE	Weight	Demision
CM006A	3/4inch	6M	STAINLESS STEEL		
CM008A	3/4inch	8M	STAINLESS STEEL	20/24KGS	55x29x55
CM010A	3/4inch	10M	STAINLESS STEEL	22/24KGS	55x29x55
CM012A	3/4inch	12M	STAINLESS STEEL	25/28KGS	55x29x55
CM015A	3/4inch	15M	STAINLESS STEEL	27/30KGS	55x40x58
CM020A	3/4inch	20M	STAINLESS STEEL	31/34KGS	55x40x58
CM006D	3/4inch	6M	METAL		
CM008D	3/4inch	8M	METAL	21/24KGS	55x29x55
CM010D	3/4inch	10M	METAL	22/24KGS	55x29x55
CM012D	3/4inch	12M	METAL	25/28KGS	55x29x55
CM015D	3/4inch	15M	METAL	27/30KGS	55x40x58
CM020D	3/4inch	20M	METAL	31/34KGS	55x40x58
CM008D-1	1inch	8M	METAL	21/24KGS	55x29x55
CM012D-1	1inch	12M	METAL	29/33KGS	55x29x55
CM015D-1	1inch	15M	METAL	31/35KGS	55x40x58
CM020D-1	1inch	20M	METAL	36/40KGS	55x40x58
CM008A-H	3/4inch Horizontal type	8M	STAINLESS STEEL	20/24KGS	55x29x55
CM012A-H	3/4inch Horizontal type	12M	STAINLESS STEEL	25/28KGS	55x29x55
CM008D-H	3/4inch Horizontal type	8M	METAL	21/24KGS	55x29x55
CM012D-H	3/4inch Horizontal type	12M	METAL	25/28KGS	55x29x55
CM008D-1H	1inch Horizontal type	8M	METAL	21/24KGS	55x29x55
CM012D-1H	1inch Horizontal type	12M	METAL	29/33KGS	55x29x55

FUEL NOZZLE

FOR DIESEL



11A AUTO NOZZLE
 10-60LPM
 3/4IN



120A AUTO NOZZLE
 10-120LPM
 1IN



J60A MANUAL NOZZLE
 10-60LPM
 3/4IN



NW01 MANUAL NOZZLE
 WITH DIGITAL METER
 10-60LPM
 3/4IN OR 1IN



NW01M AUTO NOZZLE
 WITH DIGITAL METER
 10-60LPM
 3/4IN OR 1IN

Plastic Jerrican & Fuel Tank

Ideal for store gasoline, diesel, kerosene and water, Robust Fuel tank made of HDPE (antiflaming and antistatic). Robust and resistant against impact. Flexible discharge spout with integral ventilation, Cover cap is secured against loss with flex. band,



Plastic Jerry Can

Ideal for store gasoline, diesel, kerosene and water, Robust Fuel tank made of HDPE (antiflaming and antistatic). Robust and resistant against impact. Flexible discharge spout with integral ventilation, Cover cap is secured against loss with flex. band.

CM05L:5L Plastic Jerrycan
 CM10L:10L Plastic Jerrycan
 CM20L:20L Plastic Jerrycan
 CM25L:25L Plastic Jerrycan

Plastic Jerry Can



Fuel Tank

Fuel Tank

Ideal for store gasoline, diesel, kerosene and water, Robust Fuel tank made of HDPE (antiflaming and antistatic). Robust and resistant against impact. Flexible discharge spout with integral ventilation, Cover cap is secured against loss with flex. band. With 2m deliver hose and manual dispensing nozzle.

CM5301: 53L Plastic Fuel Tank. Product size : 85x42x28cm,

JERRYCAN WITH BATTERY PUMP



Jerrycan with battery pump
 Model:FT010
 10L jerrycan
 9LPM/2.7GPM battery powered pump
 auto-shut off
 48cm suction hose
 88cm delivery hose
 Size:250*120*330mm
 4pcs packing size:255x490x330mm
 Weight:13kg
 2772pcs per one 20" container



Jerrycan with battery pump
 Model:FT020
 20L jerrycan
 9LPM/2.7GPM battery powered pump
 auto-shut off
 48cm suction hose
 88cm delivery hose
 Size:310*135*400mm
 4pcs packing size:315x540x410mm
 Weight:15kg
 1600pcs per one 20" container



Jerrycan with battery pump
 Model:FT025
 25L jerrycan
 9LPM/2.7GPM battery powered pump
 auto-shut off
 48cm suction hose
 88cm delivery hose
 Size:370*165*480mm
 4pcs packing size:375x660x490mm
 Weight:17kg
 920pcs per one 20" container

BATTERY PUMP



MODEL:CM9001
FLOW RATE:12LPM/3.2GPM



MODEL:CM9002
FLOW RATE:12LPM/3.2GPM



MODEL:CM9000
Flow rate:9LPM/2.4GPM

FUEL TRANSFER TANK



DC Diesel Pump With Tank
Model:DD100E
100L/27Gallon Tank
12 volt Diesel Power Self-priming pump
40LPM/10.6GPM open flow
High quality auto-shut off nozzle
4 m of 3/4" delivery hose with swivel and crimped fittings
4 meter electric cable
Size :900*500*480mm
Weight:14kg
120Sets per one 20F container



DC Diesel Pump With Tank
Model:DD100
100L/27Gallon Tank
40LPM/10.6GPM 12V diesel pump
Pad lockable Lid
auto-shut Nozzle
4 m of 3/4" delivery hose with swivel fitting
4 meter electric cable
Size:800*757*450mm
Weight:23kg
95Sets per one 20" container



DC Diesel Pump With Tank
Model:DD200
200L/54Gallon Tank
40LPM/10.6GPM 12v diesel pump
Pad lockable Lid
High quality auto-shut off nozzle
4 m of 3/4" delivery hose with swivel fitting
4 meter electric cable
Size:1050*747*570mm
Weight:35.8kg
60Sets per one 20" container

FUEL TRANSFER TANK



DC Diesel Pump With Tank
 Model:DD210
 210L/56Gallon Tank
 40LPM, 10.6GPM 12v diesel pump
 Pad lockable Lid
 High quality auto-shut off nozzle
 4 m of 3/4" delivery hose with swivel fitting
 4 meter electric cable
 Size:1100*800*450mm
 Weight:35kg
 70Sets per one 20" container

FUEL TRANSFER TANK



DC Diesel Pump With Tank
 Model:DD210E
 210L/56Gallon Tank
 40LPM/10.6GPM 12v diesel pump
 High quality auto-shut off nozzle
 4 m of 3/4" delivery hose with swivel fitting
 4 meter electric cable
 Size :830*760*590mm
 Weight:28kg
 81Sets per one 20" container



DC Diesel Pump With Tank
 Model:DD400
 400L/106Gallon Tank
 12 volt Diesel Power Self-priming pump
 40LPM/10.6GPM open flow
 Pad lockable filling cap
 High quality auto-shut off nozzle
 4 m of 3/4" delivery hose with swivel and crimped fittings
 4 meter electric cable
 Size:1150*800*680mm
 Weight:53kg
 90Sets per one 40HQ container



400+50 combo tank for diesel and adblue
 Model:DD400PLUS40

- DC fuel transfer pump, mod. DP40012 (12 V), flow rate 40 l/min for Diesel compartment
- Diaphragm pump 12V, flow rate 17 l/min for AdBlue® compartment
- 4 m of hose for Diesel fuel and 4 m of hose for AdBlue® .
- Automatic nozzle for Diesel fuel and manual nozzle for AdBlue®
- 4 m of battery power cable and clamps for battery connection
- Lid with lock



DC Diesel Pump With Tank with Lid
 Model:DD480
 480L
 56LPM 12v diesel pump or 230V pump
 Auto shut off nozzle
 Level gauge
 10m of 3/4" hose reel
 4meter electric cable
 Locked
 Air breath
 Size:1130*950*835mm
 Weight:100kg
 72Sets per one 40HQ container



DC Diesel Pump With Tank
 Model:DD330HR
 56LPM 12v diesel pump or 230V pump
 Auto-shut off nozzle
 Level gauge
 10m of 3/4" hose reel
 4meter electric cable
 Locked
 Air breath
 Size:1150*800*690mm
 Weight:74kg
 42Sets per one 20" container

FUEL TRANSFER TANK



DC Diesel Pump With Tank with Lid
 330L DIESEL + 50L ADBLUE
 Diesel tank 330L
 40LPM 12v diesel pump
 Auto shut off nozzle
 Level gauge
 4m of 3/4" NBR hose
 4meter electric cable
 Locked
 Air breath
 Adblue tank 50L
 17LPM 12V adblue pump
 Plastic manual nozzle
 4m of 3/4" EPDM hose
 Size:1150*800*690mm
 Weight:63.5kg
 42Sets per one 20" container



MODEL:GT330HR
 DC Gasoline Pump With Tank with Lid
 330L
 57LPM 12v gasoline pump
 Auto shut off nozzle
 Level gauge
 10m of 3/4" hose reel
 4meter electric cable
 Locked
 Air breath
 Size:1150*800*690mm
 Weight:80kg
 42Sets per one 20" container



MODEL:GT330
 DC Gasoline Pump With Tank with Lid
 330L
 57LPM 12v gasoline pump
 Auto shut off nozzle
 Level gauge
 10m of 3/4" hose reel
 4meter electric cable
 Locked
 Air breath
 Size:1150*800*690mm
 Weight:60kg
 42Sets per one 20" container

FUEL TRANSFER TANK



DC Diesel Pump With Tank
 Model:DD500
 500L/133Gallon Tank
 12 volt Diesel Power Self-priming pump
 40LPM/10.6GPM open flow
 Pad lockable filling cap
 High quality auto-shut off nozzle
 4 m of 3/4" delivery hose with swivel and crimped fittings
 4 meter electric cable
 Size:1720*760*760mm
 Weight:57.6kg
 60Sets per one 40HQ container



DC Diesel Pump With Tank with Lid
 Model: DD980
 980L tank with hose reel
 56LPM 12v diesel pump or 230V pump
 Auto-shut off nozzle
 Level gauge
 Led Light
 10m of 3/4" hose reel
 4meter electric cable
 Locked
 Air breath
 Water Separator
 Size:1100*1300*1200mm
 Weight:120kg
 16Sets per one 20" container



DC Diesel Pump With Tank
 Model:DD1000
 1000L/266Gallon Tank
 12 volt Diesel Power Self-priming pump
 40LPM/10.6GPM open flow
 Pad lockable filling cap
 High quality auto-shut off nozzle
 4 m of 3/4" delivery hose with swivel and crimped fittings
 4 meter electric cable
 Size:1680*1130*860mm
 Weight:100kg
 42Sets per one 40HQ container



Safety ball
 1000L tank need put 100pcs.

FUEL TRANSFER TANK



DC Diesel Pump With Mobile Tank
 Model:DD7801
 75L/20Gallon Mobile Tank
 12 volt Diesel Power Self-priming pump 40LPM/10.6GPM open flow
 High quality manual nozzle
 4 m of 3/4" delivery hose with swivel and crimped fittings
 4 meter electric cable
 Size:480*530*1050mm Weight:17kg
 110Sets per one 20F container



DC Diesel Pump With Mobile Tank
 Model:DD7802
 75L/20Gallon Mobile Tank
 12v/230v pump(Li-ion battery option)
 pump 18LPM open flow
 High quality manual nozzle
 2m of 3/4" delivery hose with swivel and crimped fittings
 4 meter electric cable
 Size :480*530*1050mm
 Weight:15kg
 110Sets per one 20F container



MODEL:CM5301B
 53L TANK
 Battery pump
 2M Delivery hose

FUEL TRANSFER TANK



DC Diesel Pump With Mobile Tank
 Model:DD7801
 75L/20Gallon Mobile Tank
 12 volt Diesel Power Self-priming pump 40LPM/10.6GPM open flow
 High quality manual nozzle
 4 m of 3/4" delivery hose with swivel and crimped fittings
 4 meter electric cable
 Size :480*530*1050mm
 Weight:15kg
 110Sets per one 20F container



Hand Gas Pump With Mobile Tank
 Model:DM7801
 75L/20Gallon Mobile Tank
 Manual ratory pump
 20LPM/5.6GPM open flow
 High quality manual nozzle
 4 m of 3/4" delivery hose with swivel and crimped fittings
 Size :480*530*1050mm
 Weight:13kg
 110Sets per one 20F container



Hand Gas Pump With Mobile Tank
 Model:GM7801
 75L/20Gallon Mobile Tank
 Manual ratory pump
 20LPM/5.6GPM open flow
 High quality manual nozzle
 4 m of 3/4" delivery hose with swivel and crimped fittings
 Size :480*530*1050mm
 Weight:13kg
 110Sets per one 20F container

ADBLUE TRANSFER TANK



DC Adblue pump with tank
Model:AD100E
100L/27Gallon Tank
12 volt Diesel Power Self-priming pump
17LPM/4.5GPM open flow
High quality manual nozzle
4 m of 3/4" delivery hose
4 meter electric cable
Size:900*500*480mm
Weight:13kgs
120Sets per one 20F container



DC Adblue pump with mobile tank
Model:AD7801
75L/20Gallon Mobile Tank
12 volt Diesel Power Self-priming pump
17LPM/4.5GPM open flow
High quality manual nozzle
4 m of 3/4" delivery hose
4 meter electric cable
Size:480*530*1050mm
Weight:15kgs
110Sets per one 20F container



CAR FILLING SYSTEM
Model:AD7802
75L/20Gallon Mobile Tank
GP10012 10LPM/2.6GPM open flow
Diaphragm pump
AD14PP automatic nozzle with 15mm spot
out 5-10LPM
4 m of 3/4" delivery hose with swivel and
crimped fittings
Size:450*530*1050mm
Weight:15kg
110Sets per one 20F container

ADBLUE TRANSFER TANK



Adblue manual pump with mobile tank
Model:AM7802
75L/20Gallon Mobile Tank
Manual rotary pump
20LPM/5.6GPM open flow
2 m of 3/4" delivery hose
Size:480*530*1050mm
Weight:11kg
110Sets per one 20F container



CAR FILLING SYSTEM
Model:AD7803
75L/20Gallon Mobile Tank
GP10012 10LPM/2.6GPM open flow
Diaphragm pump
AD14PP automatic nozzle with 15mm spot
out 5-10LPM
4 m of 3/4" delivery hose with swivel and
crimped fittings
Size:450*530*1050mm
Weight:15kg
110Sets per one 20F container

ADBLUE TRANSFER TANK



DC ADBLUE Pump With Tank
 Model:AD100
 100L/27Gallon Tank
 12 volt Self-priming diaphragm pump
 17LPM/4.5GPM open flow
 Pad lockable filling cap
 High quality auto-shut nozzle AD11PP
 4 m of 3/4" delivery hose
 4 meter electric cable
 Size:800*757*450mm
 Weight:23kg
 95Sets per one 20" container



DC Adblue Pump With Tank
 Model:AD200
 200L/54Gallon tank
 12 volt Self-priming diaphragm pump
 23LPM/6.8GPM open flow
 High quality MANUAL nozzle
 4 m of 3/4" delivery hose
 4 m electric cable
 30 min duty cycle, 30 min on/off
 Size:1100*640*610mm
 Weight:27kg
 60Sets per one 20" container



DC Adblue Pump With Tank
 Model:AD210
 200L/54Gallon tank
 12 volt Self-priming diaphragm pump
 23LPM/6.8GPM open flow
 High quality manual nozzle
 4 m of 3/4" delivery hose
 4 m electric cable
 30 min duty cycle, 30 min on/off
 Size:1100*640*610mm
 Weight:35kg
 60Sets per one 20" container

ADBLUE TRANSFER TANK



DC Adblue Pump With Tank
 Model:AD210E
 210L/56Gallon Tank
 17LPM 12v Adblue pump
 High quality manual nozzle
 4 m of 3/4" delivery hose
 4 meter electric cable
 Size:830*760*590mm
 Weight:27kg
 81Sets per one 20" container



DC Adblue Pump With Tank
 Model:AD400
 400L/108Gallon tank
 12 volt Self-priming diaphragm pump
 23LPM/6.8GPM open flow
 High quality manual nozzle
 4 m of 3/4" delivery hose
 4 m electric cable
 30 min duty cycle, 30 min on/off
 Size:1100*640*610mm
 Weight:49kg
 42Sets per one 20" container



DC Adblue Pump With Tank
 Model:AD500
 500L/133Gallon Tank
 12 volt Self-priming diaphragm pump
 23LPM/6.8GPM open flow
 High quality auto plastic nozzle
 4 m of 3/4" delivery hose
 4 m electric cable
 30 min duty cycle, 30 min on/off
 Size: 1720*760*760mm
 Weight:46kg
 60Sets per one 40HQ container

ATV SPRAYER/SPOT SPRAYER



SPECIFICATION: Electrical System Requirements:

MODEL:	FLSP-15-038	FLSP-15-046	FLSP-15-061
Electrical connection:	12V DC		
Amp draw from pump:	2.2 amp	3.8 amp	3.5 amp
Pump flow :	3.8L/Min	4.3L/Min	6.1L/Min
Pump Pressure :	60PSI	60PSI	60PSI
Maximum tank capacity:	50L/14G		
Overall Dimensions:			
Length:	840mm		
Width:	380mm		
Height:	400mm		
Weight:			
Unladen:	13.61 kg		
Laden:	73.61 kg		
Component Materials:			
Tank:	Polyethylene, EPDM		
Suction tube:	Polypropylene, PVC, Stainless Steel		
Hose:	PVC		
Pump:	Polypropylene, Viton, Sanoprene		
Valves:	PVC, Buna-N		
Gun and Nozzle:	Brass, Nylon, Polyacetal		
Additional notes:			
1. Hand lance hose supplied is 4.70 metres			
2. The unit is supplied with 2 x ratchet straps for attaching to e.g. Rear pannier			
3. The pump on this unit is suitable to supply up to a further 6 nozzles if adding a boom.			

FIRE FIGHTING SYSTEM



FFT210
 Fire fighting pump 130L/min open flow
 powered by the 1.4HP 4 Stroke engine
 Baffle design to reduce surge when transport
 Forklift feet
 30 meters 3/4" fire fighting hose with poly nozzle
 Tank Size: 200L
 Pump Size: 1inch, 3/4inlet and outlet
 Pressure Rate: 4BAR
 Packing size: 1100*800*470mm
 Weight: 50kgs



FFT400
 Fire fighting pump 130L/min open flow
 powered by the 1.4HP 4 Stroke engine
 Baffle design to reduce surge when transport
 Forklift feet
 30 meters 3/4" fire fighting hose with poly nozzle
 Tank Size: 400L
 Pump Size: 1inch, 3/4inlet and outlet
 Pressure Rate: 4BAR
 Packing size: 1130*800*720mm
 Weight: 65kgs



WATER PUMP
 Flow(m³/h) : 8
 Lift(m) : 30
 Suction length(m) : 8
 Matched engine : 140FA
 Discharging capacity(cc) : 37.7
 Petrol tank capacity(L): 0.65
 Max.power(kw/r/min) : 1.0(1.4HP)/6500
 Inlet&outlet size(inch): 1"

FIRE FIGHTING SYSTEM

FFT200

Fire fighting pump 130L/min open flow
powered by the 1.4HP 4 Stroke engine
Baffle design to reduce surge when transport
Forklift feet
30 meters 3/4" fire fighting hose with poly nozzle
Tank Size:200L
Pump Size: 1inch,3/4inlet and outlet
Pressure Rate:4BAR
Packing size:1150*750*570mm
Weight:40kgs



FFT500

Fire fighting pump 130L/min open flow
powered by the 1.4HP 4 Stroke engine
Baffle design to reduce surge when transport
Forklift feet
30 meters 3/4" fire fighting hose with poly nozzle
Tank Size:500L
Pump Size: 1inch,3/4inlet and outlet
Pressure Rate:4BAR
Packing size:1720*760*760mm
Weight:62kgs



FFT1000

Fire fighting pump 130L/min open flow
powered by the 1.4HP 4 Stroke engine
Baffle design to reduce surge when transport
Forklift feet
30 meters 3/4" fire fighting hose with poly nozzle
Hose reel with 30 metres 3/4" fire fighting hose with poly fire fighting nozzle
Tank Size: 1000L
Pump Size: 1inch,3/4inlet and outlet
Pressure Rate:4BAR
Packing size:1720*1100*760mm
Weight: 110kgs



LITHIUM BATTERY GREASE GUN

MODEL: C6-2 Pump Speeds -39.99

- 2.0Ah Lithium ion battery inside
- Clear plastic tube to see the remaining grease level
- 10000PSI max. pressure
- Easy greasing the equipment
- Type C USB charging with phone charger adapter
- Flexible and steel hose
- 4Jaws nozzle and tip nozzle
- Package: carton size 45*24*11cm per set
- Color: Red, blue, yellow, black
- OEM customized requirements available
- OEM Brand sticker free

Mode P(pressure)	10000PSI max.	80±10g/min
Mode V(Volume)	5000PSI max.	120±10g/min



MODEL: C8 -37.99

- 2.0Ah Lithium ion battery inside
- Clear plastic tube to see the remaining grease level
- 8000PSI high pressure
- 80g/min high flow rate
- Easy greasing the equipment
- Type C USB charging with phone charger adapter
- Flexible and steel hose
- 4Jaws nozzle and tip nozzle
- Package: carton size 45*24*11cm per set
- Color: Red, blue, yellow, black
- OEM customized requirements available
- OEM Brand sticker free



MODEL: C21-21V with LCD display

- 21V-2.0Ah Lithium ion battery
- LCD display for real time reading:
 - Battery level
 - High/Low speed
 - Grease out put
 - g/oz transfer
- Work light
- 3 points standing
- Anti-Spring flexible hose
- 4jaws nozzle
- Blow case size: 65*36*16cm
- Carton size(3pcs in):66*38*18cm
- 20GP load:300pcs



LITHIUM BATTERY GREASE GUN

MODEL: C19-18.5V

- 18.5V Lithium battery 2.0Ah
- Max. pressure 10000PSI(689bar)
- Flow rate: 90±10g/min
- Cartridge capacity: 400/450g
- Bulk capacity: 450/500g
- Charger: 110-240VAC
- Charge time: 60±10min
- Anti-spring flexible hose
- 4jaws nozzle
- 3pcs in one carton: 56*34*44cm 20kg
- One 20GP can load 810pcs



MODEL: C18-18.5V

- 18.5V Lithium battery 2.0Ah
- Max. pressure 10000PSI(689bar)
- Flow rate: 90±10g/min
- Cartridge capacity: 400/450g
- Bulk capacity: 450/500g
- Charger: 110-240VAC
- Charge time: 60±10min
- Anti-spring flexible hose
- 4jaws nozzle
- 3pcs in one carton: 56*32*44cm 20kg
- One 20GP can load 800pcs



MODEL: C12-14.4V

- 14.4V Lithium battery 1.5Ah
- Max. pressure 7000PSI
- Flow rate: 60±10g/min
- Cartridge capacity: 400/450g
- Bulk capacity: 450/500g
- Charger: 110-240VAC
- Charge time: 60±10min
- Anti-spring flexible hose
- 4jaws nozzle
- 3pcs in one carton: 46*30*39cm 15kg
- One 20GP can load 1170pcs



LITHIUM BATTERY GREASE GUN

MODEL: C20 with battery indicator

- Battery indicator
- 400g/450g barrel
- 10000PSI(689bar) pressure
- Flow rate: 100±10g/min
- 2.0Ah lithium battery
- Quick charger suit for 110-240V AC input
- Anti-spring flexible hose
- 4jaws nozzle
- 3pcs in one carton size: 56*33*44cm 22kg
- OLM brand available



MODEL: C15 -18.5V with pump speed adjustable

- Adjustable pump speeds
- Pump speed and flow rate can be adjusted from
- Pressure range: 10000PSI-3000PSI
- Flow rate range: 30-170g/min
- Max. pressure 10000PSI(689bar)
- 3 points standing
- 2.0Ah Lithium battery
- Anti-spring flexible hose
- 4jaws nozzle
- 3pcs in one carton: 55*41*35cm 18kg
- 20GP can load 750pcs



MODEL: C14 -14.4V

- 14.4V/18V can be used
- 1.5Ah/2.0Ah lithium battery
- Max. pressure: 8000±1000PSI
- Cartridge capacity: 400/450g
- Flow rate: 90±10g/min
- Anti-spring flexible hose
- 4jaw nozzle
- 3pcs in one carton: 46*30*39cm 15kg
- 20GP can load 1170pcs



Digital Meter Oil Control Valve

The oil meter control valve is a compact reliable, lightweight instrument for controlling fluid deliveries in the most disparate conditions of use, with oval gear and mechanical counter. The oval gear measuring system guarantees high precision, with low pressure loss. It can be used in even the worst conditions. A strong aluminium body provides advanced resistance to high pressure. The oil meter control valve can be fitted with a nozzle and integrated with different ends to suit specific requirements. The nozzle is fitted with a balance valve for reduced trigger pressure.



Digital Meter Oil Gun

Specification:

Electronic card with LCD housed in cover
 Calibrate on-site using an easy procedure
 5-digit liquid crystal display
 4 units and battery indicator
 Dispense and totalize in L, GAL, PT and QT
 Battery power supply is 3V CR123A

Flow rate: 1 to 30L /min
 Precision: +/- 1% in all flow range
 Repetitiveness: 0.2%
 Viscosity: 8-5000mPas
 Loss of pressure: 0.7 bar
 Max working pressure : Max 70 bar
 Input with rotating 1/2" BSP/NPT
 Meter body input/output: 1/2" BSP/NPT

Item	Description	Spout	Tip
80981023	with digital meter	Flexible	Automatic
70961023	with digital meter	Flexible	Automatic

Oil Control Valve

Specification:

Flow rate: 1 to 30L /min
 Max working pressure : Max 70 bar
 Input with rotating 1/2" BSP/NPT
 Meter body input/output: 1/2" BSP/NPT

Item	Description	Spout	Tip
70960023	without digital meter	Flexible	Automatic

Oil meter accessories

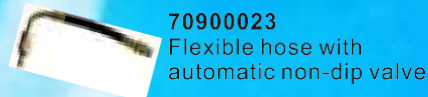

70900023
 Flexible hose with automatic non-dip valve



70900003
 Automatic non-dip valve

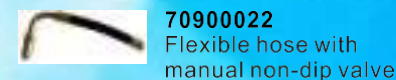

70900022
 Flexible hose with manual non-dip valve

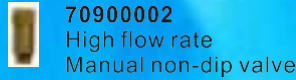

70900002
 High flow rate Manual non-dip valve

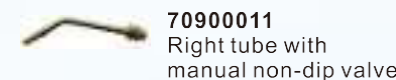

70900011
 Right tube with manual non-dip valve

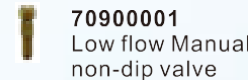

70900001
 Low flow Manual non-dip valve



Connection Hose

1/2" oil hose, SAE100R1AT, W.P.: 134 bar
 Hose end: 1/4" male BSPT/NPT fitting
 1/4" rotate female BSP/NPS fitting

Hose	Length
70781402	2m
70781404	4m
70781415	15m



Digital Meter

70901000 Inlet/outlet 1/2" female BSP/NPS

Mobile Grease Pump Unit

Mobile unit is suitable for dispensing oil for mobile application. Drum trolley ensures high mobility and efficiency. Easy to move the drum in the workshop.



Mobile Unit for 50-60kgs Drum

Standard model composed of 50:1 grease pump, trolley, grease gun with Z-swivel and 2 m connection hose

61501480	50:1 Mobile Grease Pump Unit
Includes:	
60501480	50:1 grease pump, 480mm suction tube
60910385	Drum cover, 385mm
60920370	Follow plate, 370mm
60906000	Grease gun with Z-swivel
80001050	20-60kg drum trolley
60781402	1/2"x2m greasel connection hose



Mobile Unit for 200 kgs Drum

Standard model composed of 50:1 grease pump, trolley, grease gun with Z-swivel and 2m connection hose

61501940	50:1 Mobile Grease Pump Unit
Includes:	
60501940	50:1 grease pump, 940mm suction tube
60910600	Drum cover, 600mm
60920585	Follow plate, 585mm
60906000	Grease gun with Z-swivel
80001200	180-200kg drum trolley
60781402	1/2"x2m grease connection hose



Mobile Unit for 200 kgs Drum with Hose Reel

Standard model composed of 50:1 grease pump, trolley, grease gun with Z-swivel, 2m connection hose and industrial oil hose reel

61501948	50:1 Mobile Oil Pump Unit
Includes:	
60501940	50:1 grease pump, 940mm suction tube
60910600	Drum cover, 600mm
60920585	Follow plate, 585mm
60906000	Grease gun with Z-swivel
80002208	180-200kg drum trolley
60781402	1/2"x2m grease connection hose
IRN3152	Industrial grease hose reel 1/4"x15m

FOR MARINE/SOLAR



Model	Max Head	VOLTAGE	OUTLET DIA	CURRENT
FP-350	3M	12V/24V	19MM/29MM	1.8A/1A
FP-550	3M	12V/24V	19MM/29MM	2.2A/1.2A
FP-750	4M	12V/24V	19MM/29MM	2.5A/1.25A
FP-1100	4M	12V/24V	29MM	3.0A/1.5A
FP-1500	5M	12V/24V	29MM	7A/5A
FP-2000	6M	12V/24V	29MM	8A/5.5A
FP-3000	8M	12V/24V	40MM	10A/6A
FP-3500	8M	12V/24V	40MM	12A/6A
FP-3700	8M	12V/24V	40MM	16A/8A
FP-4700	8M	12V/24V	40MM	18A/9A



3 Guang waterproof Switch Panel PT-03
 4 Gang Waterproof Switch Panel PT-04
 6 Guang waterproof switch panel PT-06
 4Way splash proof switch NT-04
 6Way splash proof switch NT-06

FOR MARINE/RV/INDUSTRY



FLM SERIES MACERATOR PUMP

FLW SERIES WATER PUPPY

Model	Volts	Flow	Pressure Off	Amp Draw
		L/min	Off	at 10 psi
FLM-12	12V	55/12GPM	No	7
FLM-24	24V	55/12GPM	No	3
FLW-12	12V	45	No	7
FLW-24	24V	45	No	3



GEAR OIL PUMP

Model	Volts dc	Open Flow gpm (lpm)	Amps Max	Packing Size (mm)	N.W / G.W (kg)
FL9-12	12 Vdc	3.7 (14.0)	3.8	215X35X10	2.75 / 3.00
FL9-24	24 Vdc	3.7 (14.0)	2.0	215X35X10	2.75 / 3.00



HIGH PRESSURE PUMP

Model	Volts	Flow Rate (L/Min)	Pressure Off	Max Amps
DP-60	12	4.6	60psi	7
DP-80	12	5.3	80psi	8
DP-100	12	4.5	100psi	9
DP-120	12	3.3	120psi	9.5
DP-160	12	5.5	160psi	10.5



DUPLEX PUMP

Model	Volts	Flow Rate (L/Min)	Pressure Off	Max Amps
FDP61230	230V	6.1	60psi	1.5A
FDP61012	12V	6.1	60psi	3.5A
FDP61024	24V	6.1	60psi	2.0A

FOR MARINE /RV/AGRICULTURE

WITH 360° SWIVEL

WITH ON/OFF SWITCH

- Compact automatic demand water system pump
- Built-in pressure switch auto-matically starts and stops pump when faucet is opened and closed
- Self-priming so pump can be located above water tank
- Runs dry for extended periods of time
- Built-in thermal protector
- Also available without switch for manual application

Model	Volts	Open Flow	Pressure	Amps @	On/Off switch
	dc	L/Min	on / off	10 psi (0.7 bar)	Included
FL- 221020	12	2	55 psi	1.6	No
FL- 221026	12	2.6	60 psi	1.8	No
FL- 221030	12	3	60 psi	2.0	No
FL- 221038	12	3.8	35 psi	2.2	No
FL- 221046	12	4.3	40 psi	3.8	No
FL- 241026	24	2	55 psi	0.9	No
FL- 241038	24	3.8	35 psi	1.1	No
FL- 221020 S	12	2	55 psi	1.6	Yes
FL- 221026 S	12	2.6	35 psi	2	Yes
FL- 221030 S	12	3	60 psi	2.0	Yes
FL- 221038 S	12	3.8	35 psi	2.2	Yes
FL- 221046 S	12	4.3	40 psi	3.8	Yes
FL- 241026 S	24	2	55 psi	0.9	Yes
FL- 241038 S	24	3.8	35 psi	1.1	Yes
FL- 241046 S	24	4.3	40 psi	1.9	Yes

SPILL PALLET

SPILL PALLET FOR 2DRUM

Model:SP-02
 Liquid volume:120L
 Load bearing:1300kgs
 4 Way forklift entry type
 Size:1300*700*300mm
 Weight:19kg
 20GP:220PCS
 40HQ:650PCS



SPILL PALLET FOR 4DRUM

Model:SP-04
 Liquid volume:240L
 Load bearing:2700kgs
 4 Way forklift entry type
 Size:1300*1300*300mm
 Weight:36kg
 20GP:132PCS
 40HQ:342PCS

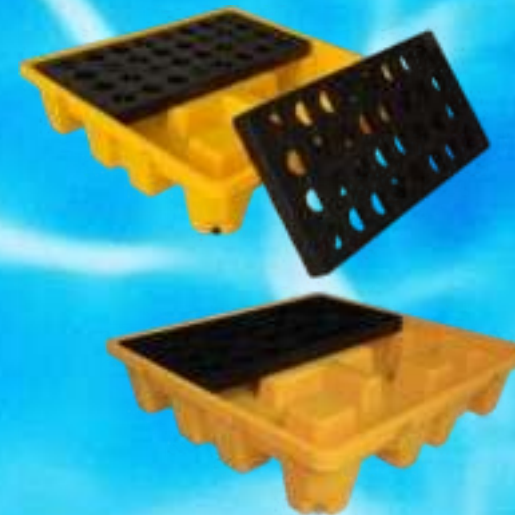

- IBC01
- 100% polyethylene - no rust or corrosion
- Flat removable grate - safe loading, quick sump access
- Forkliftable for easy relocation (empty only)
- Load rating: 1500kgs
- Sump capacity: 1,200L
- Weight: 80kgs
- Dimensions: 750 x1680 x 1680mm (h,w,d)



1680*1680*750

SPILL PALLET



SPILL PALLET FOR 4DRUM AND IBC

Model:SP-04-H

Liquid volume:600L

Load bearing:2700kgs

4 Way forklift entry type

Size:1300*1300*660mm

Weight:55kg

20GP:60PCS

40HQ:150PCS

SPILL PALLET



2340*1300*750

- IBC02
- 100% polyethylene – no rust or corrosion
- Flat removable grate – safe loading, quick sump access
- Forkliftable for easy relocation (empty only)
- Load rating: 3,000kgs (1,500kgs per side)
- Sump capacity: 1800L
- Weight: 110kgs
- Dimensions: 750 x 2340 x 1300mm (h,w, d)

SPILL PALLET FOR 2DRUM

Model:SP-02-H

Liquid volume:300L

Load bearing:1300kgs

4 Way forklift entry type

Size:1300*700*660mm

Weight:30kg

20GP:120PCS

40HQ:320PCS



645*590*820

- DRAINER
- Sump capacity: 100L
- Weight: 12kgs
- Dimensions: 645 x 590 x 820mm (h,w, d)



Loading Ramp

For 2drum and 4 drum use

Size:1150*790*300mm

Weight:22kg

FOR RV/BEVERAGE/WATER

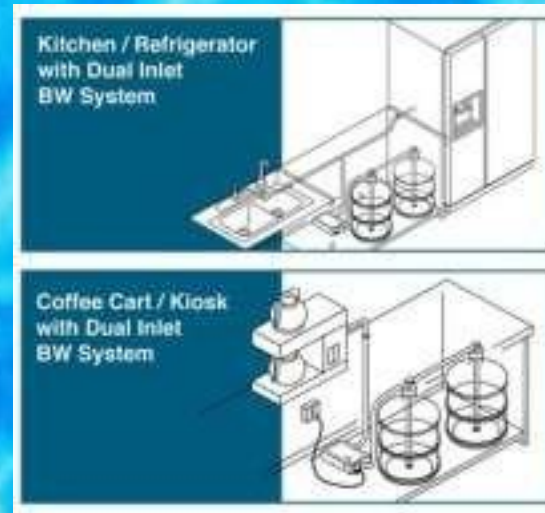

DUAL INLET BOTTLED WATER PUMP DISPENSING SYSTEM

- The COMBO Model CBW SERIES
- At just 6"x8" the new bottled water dispensing system is the most compact system you can buy and it is the most affordable.
- Max flow : 1.0 gpm(3.8L/min)
- Max pressure : 40 psi (2.8 bar).
- Power input voltage : 115 vac., 110v, 120v, 12v-48v, 220-240v
- Power input amps : 0.5 amps max.
- Weight : 5.6 net lbs.
- Cycle : 50-60 hz.
- Includes cord with plug attached.
- COMBO model number is CBW1150,CBW2300,CBW1000
- 5 gallon water bottle not included.
- Dimensions:3.0"Hx5.5"Wx7.5D(76x140x190mm)-control box
- Standard Models include 20 ft. (6.1m) of 1/4 in. (0.6 cm) tube;3.5 ft. (1 m) cord with plug

MODEL	CBW1150A-D	CBW1150B-D	CBW2300A-D	CBW2300B-D	CBW1000A-D	CBW1000B-D
Max Flow /Min	3.8L/1.0GPM	3.8L/1.0GPM	3.8L/1.0GPM	3.8L/1.0GPM	3.8L/1.0GPM	3.8L/1.0GPM
Operating Pressure	40PSI	40PSI	40PSI	40PSI	40PSI	40PSI
Working Flow/Min	2L/0.5GPM	1.5L/0.4GPM	2L/0.5GPM	1.5L/0.4GPM	2L/0.5GPM	1.5L/0.4GPM
Current	0.5Amps.max	0.5Amps.max	0.25Amps.max	0.25Amps.max	3.0Amps.max	3.0Amps.max
Noise level:	65db	45db	65db	45db	65db	45db
volt.	110/115/120VAC	110/115/120VAC	220/230/240VAC	220/230/240VAC	12/24/36/48VDC	12/24/36/48VDC
Carton Dimension	60X9.5X26CM					
WEIGHT:	3.5KGS					
20F CONTAINER	2000PCS					
40F CONTAINER	4000PCS					
40HQF CONTAINER	4280PCS					

FOR RV/BEVERAGE/WATER

SINGLE INLET BOTTLED WATER PUMP DISPENSER SYSTEM
-----new type

- The COMBO Model CBW SERIES
- At just 6"x8" the new bottled water dispensing system is the most compact system you can buy and it is the most affordable.
- Max flow : 1.0 gpm(3.8L/min)
- Max pressure : 40 psi (2.8 bar).
- Power input voltage : 115 vac., 110v, 120v, 12v-48v, 220-240v
- Power input amps : 0.5 amps max.
- Weight : 5.6 net lbs.
- Cycle : 50-6 hz.
- Includes cord with plug attached.
- COMBO model number is CBW1150,CBW2300,CBW1000
- 5 gallon water bottle not included.
- Dimensions:3.0"Hx5.5"Wx7.5D(76x140x190mm)-control box
- Standard Models include 20 ft. (6.1m) of 1/4 in. (0.6 cm) tube;3.5 ft. (1 m) cord with plug



MODEL	CBW1150A-N	CBW1150B-N	CBW2300A-N	CBW2300B-N	CBW1000A-N	CBW1000B-N
Max Flow /Min	3.8L/1.0GPM	3.8L/1.0GPM	3.8L/1.0GPM	3.8L/1.0GPM	3.8L/1.0GPM	3.8L/1.0GPM
Operating Pressure	40PSI	40PSI	40PSI	40PSI	40PSI	40PSI
Working Flow/Min	2L/0.5GPM	1.5L/0.4GPM	2L/0.5GPM	1.5L/0.4GPM	2L/0.5GPM	1.5L/0.4GPM
Current	0.5Amps.max	0.5Amps.max	0.25Amps.max	0.25Amps.max	3.0Amps.max	3.0Amps.max
Noise level:	65db	45db	65db	45db	65db	45db
volt.	110/115/120VAC	110/115/120VAC	220/230/240VAC	220/230/240VAC	12/24/36/48VDC	12/24/36/48VDC
Carton Dimension	60X9.5X26CM					
WEIGHT:	3.0KGS					
20F CONTAINER	2000PCS					
40F CONTAINER	4000PCS					
40HQF CONTAINER	4280PCS					

SPECIAL FEATURES

- Float switch for automatic shut off when bottle is empty
- Built-in check valve to prevent back flow
- Universal seal cap fits most water containers
- Compact size for easy mounting
- 20" discharge hose include
- Easily Installed



FOR BOTTLED WATER/BEVERAGE



**CBW SERIES
BOTTLED WATER PUMP**



Includes:
Suction wand and hose assembly.
Pump module with On/Off switch.
6 foot cord with plug.
20 feet of 1/4 " discharge tube.
Refrigeration fitting.
Universal seal cap:Fits any 3,5, and 6 gallon plastic water bottle.
Installation and maintenance instructions.

Specifications:

Model:	CBW1150A	CBW1150B	CBW2300A	CBW2300B	CBW1000A	CBW1000B
Max Flow/Min:	3.8L/1.0GPM	3.8L/1.0GPM	3.8L/1.0GPM	3.8L/1.0GPM	3.8L/1.0GPM	3.8L/1.0GPM
Operating pressure:	40PSI	40PSI	40PSI	40PSI	40PSI	40PSI
Working Flow/Min:	2L/0.5GPM	1.2L/0.3GPM	2L/0.5GPM	1.2L/0.3GPM	2L/0.5GPM	1.2L/0.3GPM
Noise Level:	65db	45db	65db	45db	65db	45db
Volt:	115V	115V	230V	230V	12V	12V
Carton dimension:	60 × 9.5 × 26CM					
Weight:	3.0KGS					
20F CONTAINER:	1860PCS					

**FLOW RATE TO 7 GPM
G57 SERIES AIR PUMP
FEATURES**

- Flow rates from 0 to 7 GPM (0 to 26.5 l/min.)
- Operating pressure to 100 psi (8.3 bar)
- Self-priming
- Automatic Demand Control
- Available in a variety of chemical resistant materials

FOR RV/BEVERAGE/WATER

DUAL BOTTLED WATER PUMP DISPENSER SYSTEM

-----new type

- The COMBO Model CBW SERIES

At just 6"x8"the new bottled water dispensing system is the most compact system you can buy and it is the most affordable.

- Max flow : 1.0 gpm(3.8L/min)
- Max pressure : 40 psi (2.8 bar).
- Power input voltage : 115 vac., 110v,120v,12v-48v,220-240v
- Power input amps : 0.5 amps max.
- Weight : 5.6 net lbs.
- Cycle : 50-60 hz.
- Includes cord with plug attached.
- COMBO model number is CBW1150,CBW2300,CBW1000
- 5 gallon water bottle not included.
- Dimensions:3.0"Hx5.5"Wx7.5D(76x140x190mm)-control box
- Standard Models include 20 ft. (6.1m) of 1/4 in. (0.6 cm) tube;3.5 ft. (1 m) cord with plug



SPECIAL FEATURES

- Float switch for automatic shut off when bottle is empty
- Built-in check valve to prevent back flow
- Universal seal cap fits most water containers
- Compact size for easy mounting
- Easily Installed

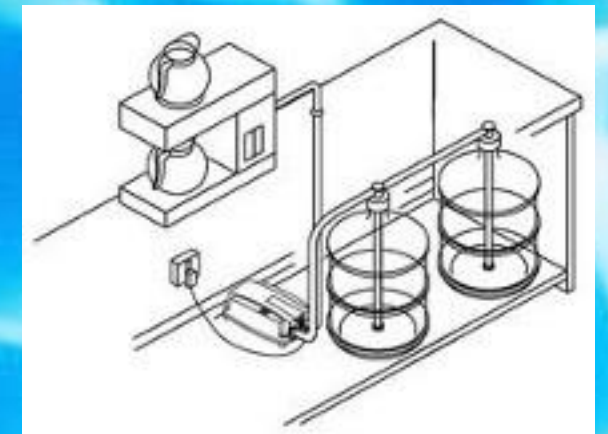

MODEL	CBW1150A-ND	CBW1150B-ND	CBW2300A-ND	CBW2300B-ND	CBW1000A-ND	CBW1000B-ND
Max Flow /Min	3.8L/1.0GPM	3.8L/1.0GPM	3.8L/1.0GPM	3.8L/1.0GPM	3.8L/1.0GPM	3.8L/1.0GPM
Operating Pressure	40PSI	40PSI	40PSI	40PSI	40PSI	40PSI
Working Flow/Min	2L/0.5GPM	1.5L/0.4GPM	2L/0.5GPM	1.5L/0.4GPM	2L/0.5GPM	1.5L/0.4GPM
Current	0.5Amps.max	0.5Amps.max	0.25Amps.max	0.25Amps.max	3.0Amps.max	3.0Amps.max
Noise level:	65db	45db	65db	45db	65db	45db
volt.	110/115/120VAC	110/115/120VAC	220/230/240VAC	220/230/240VAC	12/24/36/48VDC	12/24/36/48VDC
Carton Dimension	60X9.5X26CM					
WEIGHT:	3.5KGS					
20F CONTAINER	2000PCS					
40F CONTAINER	4000PCS					
40HQF CONTAINER	4280PCS					